



## CudaX DPV User Manual

03/29/2024

**Models Covered: DX-010-TCH, DX-010-EXP**

### General Description

The CudaX DPV series is a range of underwater tow-behind diver propulsion vehicles designed to enhance a diver's underwater experience. This owner's manual is not a training guide and should not be substituted for a proper training course. It is the diver's personal responsibility to seek proper training in the use of their CudaX DPV and to dive within the limits of their training, experience, and DPV as described in the specification.

**Original Instructions**

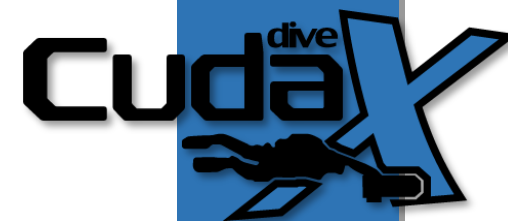

# Contents

Cautions & Warnings.....	3
Specifications.....	5
Basic Scooter Components.....	6
Batteries.....	7
Assembly.....	8
Operation.....	10
Operation Features Available Using App.....	13
Dive Planning.....	14
Scooter Failures.....	15
Post-Dive Procedures.....	17
Travel & Storage.....	18
Maintenance.....	19
Spare Parts.....	20
Troubleshooting.....	20
Compliance.....	20
Warranty & Returns.....	21

## Cautions & Warnings

### **Proper training required.**

Always seek proper DPV and dive training prior to using any DPV. Use of Dive Xtras DPVs assumes proper training. Dive Xtras will not be held liable for any injury or death while using this DPV.

### **Do not operate continuously outside of water.**

Dive Xtras DPVs are not designed for continuous surface operation. Operation for periods of time longer than 15-30 seconds outside of water may damage rotational seals and compromise sealing capability of the DPV.

### **Never ascend using your DPV to pull you towards the surface.**

This will cause a 'rapid ascent' as explained in basic diver training and should be avoided at all times. A rapid ascent can cause serious injuries such as, but not limited to, lung over-expansion injuries, decompression illness, rupture of the ear drum, and in extreme cases, even death.

### **Never allow the DPV to put you at risk.**

If at any time during your diving activity with a DPV you feel you are at risk, immediately unclip the DPV tow cord and release the DPV.

### **Placing your hands in the way of the propeller blades can cause damage and/or injury.**

Inadvertently getting your hands or other objects caught in the spinning propeller blades can cause damage to your DPV as well as to you. Dive Xtras DPVs have built in safety features to minimize this danger, but damage/injury may still occur.



### **Be careful not to entangle equipment, line, hair, seaweed, etc. in the propeller.**

This may cause the DPV propeller to slow or even stop. Ensure you stop, releasing the trigger, and untangle whatever has caused the entanglement.

### **DPV may flood if improperly sealed.**

Always follow the procedure outlined in this manual for installing batteries and sealing the DPV. If flooding does occur, follow process outlined in the "Flood Recovery" section of this manual.

### **DPV failure may cause a runaway scooter.**

Follow the procedure outlined in the "DPV Won't Stop Running" section of this manual in the event of a runaway scooter.

### **Always ensure to connect like-colored wires, whenever connecting any electric connectors.**

Always connect red to red, black to black, and blue to blue. Failure to do so will result in damage to your DPV or batteries.

### **Always ensure correct operation of the on/off trigger prior to use.**

Always ensure you check the trigger action prior to use of the DPV to ensure correct operation.

**A DPV is considered a heavy object.**

Use caution when lifting. Always use safe lifting practices when lifting your DPV and utilize built-in handles. Bend from your knees, keeping your back straight.

**When transporting your DPV on a boat, car, or airplane, always ensure your DPV is safe and restrained from movement.**

Your DPV is a heavy object. Always safely restrain your DPV when transporting to avoid damage to your DPV, its environment, or bystanders.

**Always check the strap is fastened correctly and nothing has been pinched in the seals between nose and battery tube and between battery tube and tail.**

When assembling your DPV, it is important to ensure that nothing is caught in the seals and none of the O-rings are protruding to minimize the risk of flooding.

**Your DPV is not a toy, nor a suitable rescue tool.**

It is for assistance in propulsion only. Do not rely on the DPV for ascent or assistance in an emergency.

**Not for use by children.**

DPV use and operation is not an activity suitable for children.

**Remove batteries while not in use.**

Batteries may sustain damage from prolonged installation while not in use. Battery removal also minimizes risk of inadvertent operation.

**Sound Levels:** A-weighted emission sound pressure level does not exceed 70 dB(A) during operation.

**Vibration Levels:** Hand-arm system vibration does not exceed 2.5 m/s<sup>2</sup> during operation.

**(Continued)**

## Specifications

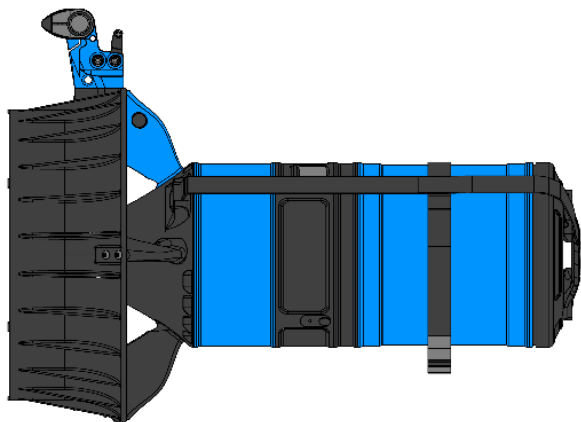

### CudaX Tech

<b>Weight:</b>	33lbs (14.9kg)
<i>(without batteries)</i>	28lbs (12.7kg)
<b>Length:</b>	25in (63.5cm)
<b>Depth Rating:</b>	550ft (168 meters)
<b>Continuous Max Speed:</b>	290ft/min (88m/min)
<b>Boost Mode Max Speed:</b>	324ft/min (98m/min)
<b>Boost Mode Max Runtime:</b>	Approximately 7 minutes
<b>Boost Mode Max Thrust:</b>	108lbs (480N)

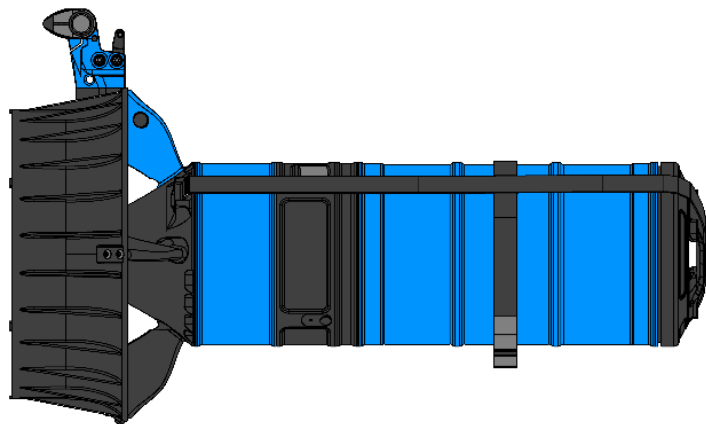

### CudaX Exploration

<b>Weight:</b>	44lbs (19.9kg)
<i>(without batteries)</i>	31.2lbs (14.2kg)
<b>Length:</b>	30in (76.2cm)
<b>Depth Rating:</b>	550ft (168 meters)
<b>Continuous Max Speed:</b>	290ft/min (88m/min)
<b>Boost Mode Max Speed:</b>	324ft/min (98m/min)
<b>Boost Mode Max Runtime:</b>	Approximately 7 minutes
<b>Boost Mode Max Thrust:</b>	108lbs (480N)

# Basic Scooter Components

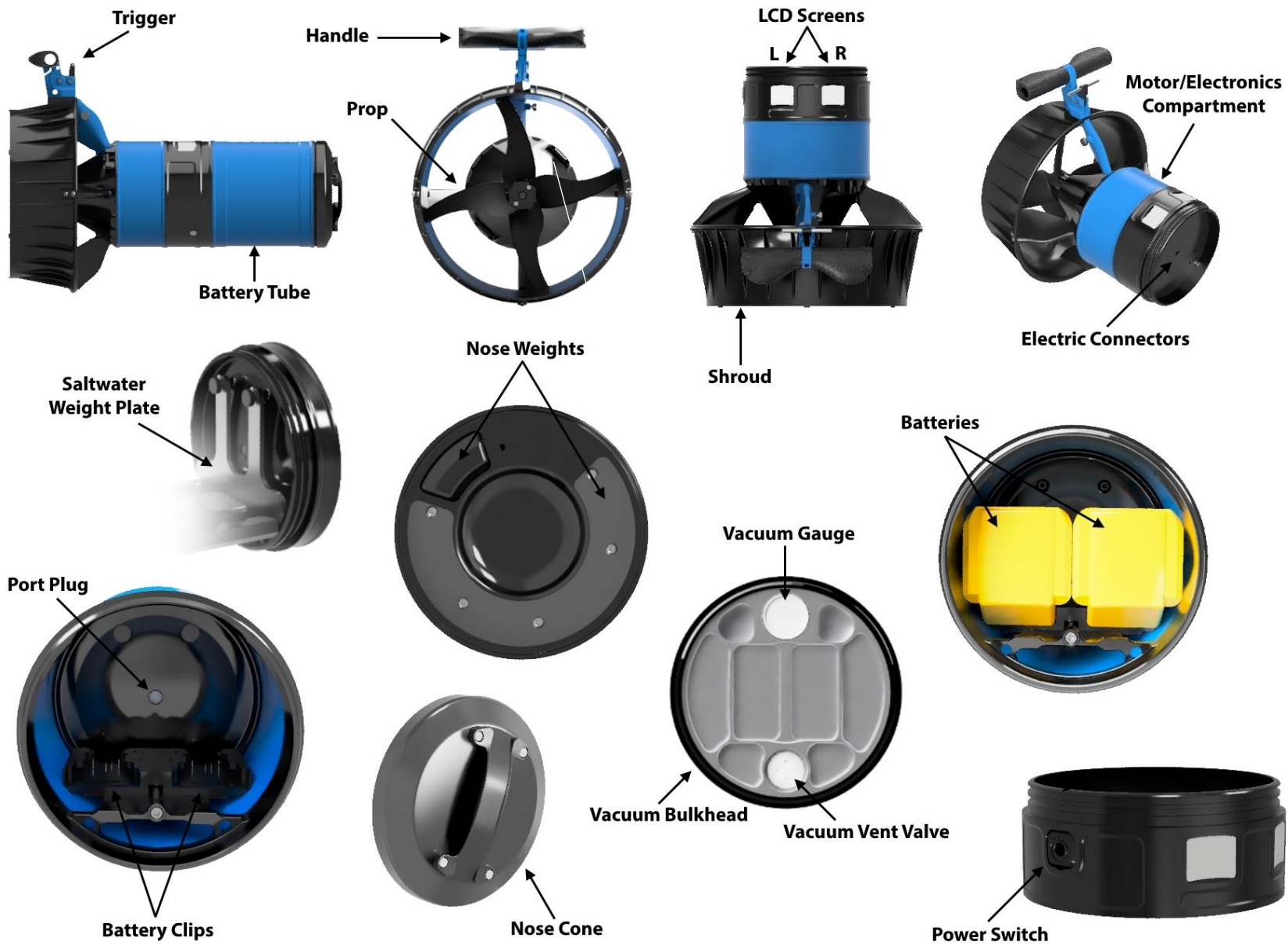

# Batteries

## Which Batteries to Use?

The DPV accepts any DCB-type power tool batteries. In the USA, these are commonly called 20v Max, whereas in Europe they are known as 18v XR. Supported amp hours are 9Ah and 12Ah battery capacities. Note that both batteries should be the same age and capacity. For optimal performance, do not mix battery capacities or ages in your DPV. Name brand batteries are not a requirement. Here in the US, we purchase our batteries and chargers online via Amazon or other retailers. You will also need to purchase a compatible charger for your batteries.

## Charging Your Batteries

Always fully charge both batteries before installing them in your DPV. This will help prevent your DPV from receiving different voltage readings from each battery and will keep your BlackTip running smoothly. Try to charge your batteries close to your dive time, and never store your batteries inside your scooter, the small power draw of the scooter will eventually drain the batteries and potentially damage them.

## Scooter Battery Info

Runtime and range will vary, depending on your choice of batteries. See below for general specs of both CudaX models.

(Batteries and charger not included with purchase of scooter)

	CudaX Tech	CudaX Exploration
Runtime @ Cruise Speed (150ft/min; 45m/min)	190 minutes	400 minutes
Range @ Cruise Speed (150ft/min; 45m/min)	5.6 miles (9.1km)	11.3 miles (18.2km)

**Compatible with 9Ah or 12Ah, 20v (USA only) or 18v batteries that fit the DCB interface.**

## Before You Dive

### Installing Your Batteries

To install your batteries into the DPV, first loosen the strap securing the cylinder and remove the nose cone off the front of the scooter. Next, remove the vacuum bulkhead by grasping the inset areas beside the vacuum gauge and pull firmly. If the vacuum bulkhead binds in the tube, push it back in, rotate slightly either direction and repeat. Then insert your batteries into the battery clips located along the length of the scooter interior. To replace the vacuum bulkhead, verify it is rotated in the correct orientation, then pressing

firmly on the bulkhead while pushing the gray vent valve to allow air to escape. Replace the nose cone by pressing firmly on all sides until it locks into place, then finish the installation by securing the strap over the top of the scooter. Install your batteries close to your dive time as possible, and never store your batteries inside your scooter. The small power draw of the scooter will eventually drain the batteries and potentially damage them.

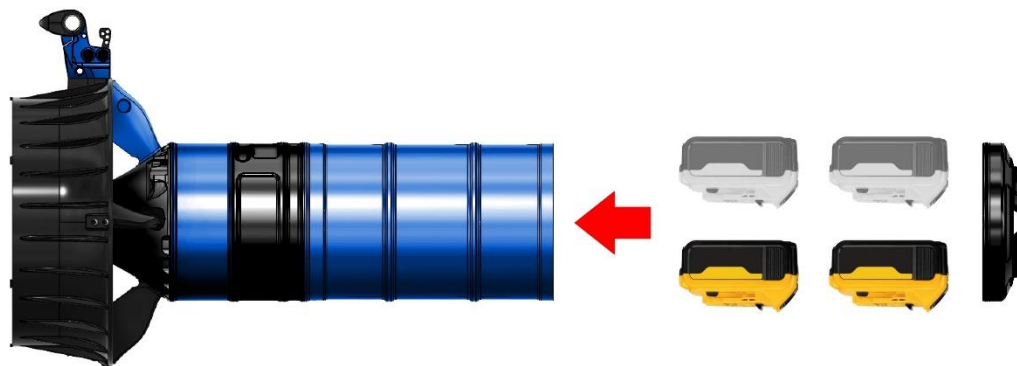

### Scooter Disassembly/Assembly

To remove the battery tube from the tail section, remove port plug in bottom of battery tube, firmly grasp battery tube, and remove. Carefully unplug electrical connector running between tail and battery tube. This connection point and its wires are not to be pulled or bent in any way! These components are not user-fixable and will need to be returned to Dive Xtras for repair if damaged. If scooter was left for an extended period under vacuum or has an internal vacuum leak between tail and battery tube it may be necessary to remove the external port plug to release vacuum in the tail. If unable to remove nose due to vacuum, remove tail section from battery tube and use a flat-head screwdriver to remove the port plug. Assembly process is the reverse of disassembly process. Please note if the port plug in battery tube is not removed during assembly/disassembly process, it will cause differential air pressure in the tail which may cause difficulty.

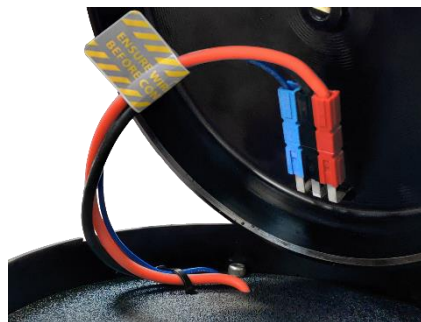



## Vacuum Check for Leaks

The vacuum bulkhead in your CudaX allows you to pull a vacuum on your DPV to check for leaks. The design of the CudaX keeps the battery tube and tail section separate in the event of a flood in either section. Consequently, the vacuum check procedure is intended to test each section and aid in diagnosis of any leaks. At minimum, Dive Xtras recommends performing a vacuum leak check on your CudaX's battery compartment before every dive and performing a full scooter vacuum leak check after each full disassembly. **Do not dive with the DPV under vacuum. This may result in an extreme pressure differential, and the inability to easily remove the nose or batteries after diving.** To release pressure, push the rubber valve tip to the side (see photo below).

### Vacuum Test Procedure - Whole Scooter (Perform After Disassembly):

- 1.) Remove port plug in bottom of battery tube, install vacuum bulkhead, press the vacuum pump against the bulkhead's rubber valve and vacuum until gauge reads at least -5inHG.
- 2.) Let sit for at least 5 minutes (15 minutes max). If there is any change in vacuum level, inspect all O-rings then re-test. If DPV continues to fail vacuum test, contact Dive Xtras for technical support.
- 3.) After completing test, release pressure by pressing sideways on the rubber valve tip located in the vacuum bulkhead.

### Vacuum Test Procedure - Battery Compartment Only (Perform Before Diving):

- 1.) Install port plug in bottom of battery tube. Install batteries and vacuum bulkhead. Press the vacuum pump against the bulkhead's rubber valve and vacuum until gauge reads at least -5inHG.
- 2.) Let sit for at least 5 minutes (15 minutes max). If there is any change in vacuum level, inspect port plug O-rings then re-test. If DPV continues to fail vacuum test, contact Dive Xtras for technical support.
- 3.) After completing test, release pressure by pressing sideways on the rubber valve tip located in the vacuum bulkhead, install nose, and dive. **Failure to release vacuum before dive may result in an extreme pressure differential, and the inability to easily remove the nose or batteries after diving.**



## Using the Tow Cord Attachment

It's very important to use the tow cord while operating your DPV, as the scooter is designed to only be used in conjunction with one. The tow-cord carries all the thrust of the scooter, allowing you to concentrate on steering and other activities. Simply adjust the sliding knot on the long end of your tow cord rope to match the length of your reach, then fasten it to your gear. The tow-cord typically attaches to a D-ring secured to the crotch area of your equipment. Some dive equipment has this attachment point built-in, in the form of a crotch strap. If your diving gear does not feature this attachment point, make sure you obtain one before operating your scooter. You can find one listed on our website or consider buying and using a climbing harness, similar to the one pictured below.



## Operation

### Buoyancy & Trim

Your DPV's buoyancy can be adjusted to suit your diving. Weight can be added or removed from the nose of the scooter. There are pockets in the nose that can be filled with steel shot. To access the pockets, remove the screws on the back of the nose cap and lift off the plastic cover plate. There is a saltwater weight plate in the back of the battery tube, remove if diving in fresh water.

**Do not try to remove weight from the tail.** There is no weight adjustment in the tail, or any removable parts.



The DPV comes trim/neutral from the factory using 12Ah batteries weighing 1455g each. If buoyancy needs to be adjusted due to variations in battery weight or the addition of accessories, we recommend adjusting it so the scooter will float trim while the handle is held.

### Powering Your DPV On & Off

The CudaX features an external power button. To power on, press and release (do not hold down) switch. LCD screen should illuminate within 2-3 seconds to indicate scooter is powered on. To power off, hold button for at least 3 seconds. Screen will turn off when DPV is powered off. You must still remove batteries after dive to avoid slow drain/damage to batteries.

### Displays

Your CudaX is equipped with dual displays that will show a variety of information.

**Right Screen:** On startup, the right screen will display the  symbol, indicating scooter is powered on and ready to run. During operation, the right screen will initially display the  symbol to indicate Safe Start, then the current selected gear number. See below for detailed information on Safe Start.

**Left Screen:** The left screen will briefly display the current battery level after startup and whenever motor operation is paused, usually preceded by a short load screen. If the DPV detects a battery error, a small "1" or "2" will appear in the corner of the screen as well, this is usually caused by a dead or damaged battery. If there continues to be an error with known-good batteries, contact [support@dive-xtras.com](mailto:support@dive-xtras.com) for technical support. See the chart below for an illustrated breakdown of each battery level and status.

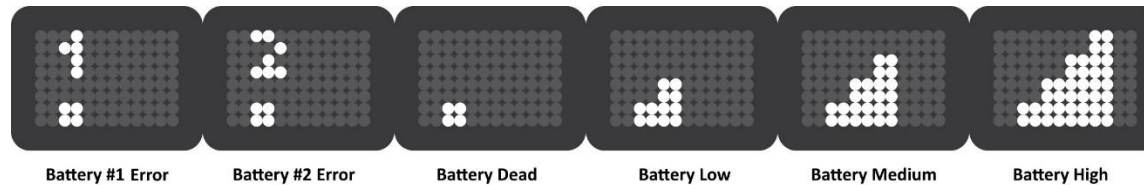

## Operating Your DPV

You'll control your DPV by using double and single clicks on the thumb trigger. Once you're in the water, double-clicking the trigger will start the DPV at speed 3, known as cruise speed. To increase speed, double-click again, once for each speed gear increase. Single-clicking will decrease your speed by one gear with each click. To stop your scooter, simply let go of the thumb trigger.

## Safe Start

When you first start the DPV, it will spin its prop slowly at low power before shifting to cruise speed. This is called "safe start". The DPV will not allow you to engage any speed gears until it has confirmed that nothing is obstructing the prop. This is to help prevent accidents.

## Speed Modes

Out of the box, the DPV comes loaded with 7 running gears plus Ludicrous Speed (not intended for nonstop running). Double-click trigger to speed up, single click to slow down. Every time you change gear the LED display will indicate the current gear.

## Ludicrous Speed

At higher speeds, such as gear 7 and Ludicrous, the current draw is quite high and running at these speeds continuously would overheat the motor and/or electronics. To prevent this, the scooter will start to throttle back its output after a while. The scooter also won't check for battery output mismatch errors while it is drawing maximum power in Ludicrous speed. A scooter restart is required to re-enable this feature if it becomes disabled.

Releasing the trigger or running at a lower speed will allow the scooter to cool itself, giving you access to the higher speeds again.

If you only use Ludicrous for brief periods, you may never even notice the time limitations.

During throttling the display will still show the commanded gear, even though speeds are reduced.

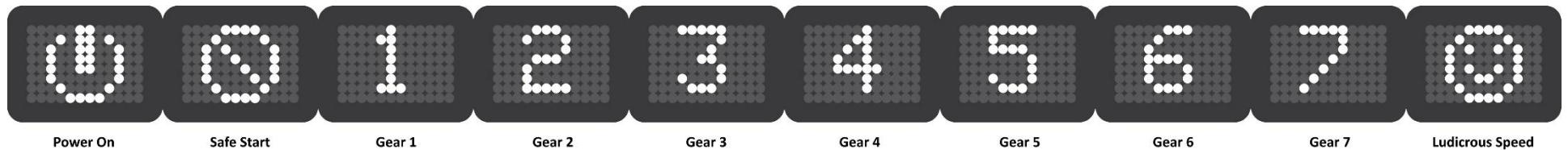

## Jump Speed

Triple clicking the trigger will enable Jump speed and your scooter will immediately go to speed 6. This is a quick way to get moving fast without having to shift through multiple speeds.

## Slow Speed Restart

If you stop the scooter at any speed less than the start speed, when you restart it will do so in the speed you stopped at. Shifting speeds to above the start speed clears this setting and you will restart in the normal start speed. This is designed to make the scooter safer for use in a sensitive environment, preventing the scooter from restarting at a speed that could be too high causing you to go too fast or silt out your location.

## Battery Status

The CudaX LED screen will display battery status bars a few seconds after motor operation is paused, and during normal operation. See the chart below for an illustrated breakdown of each battery level and status.

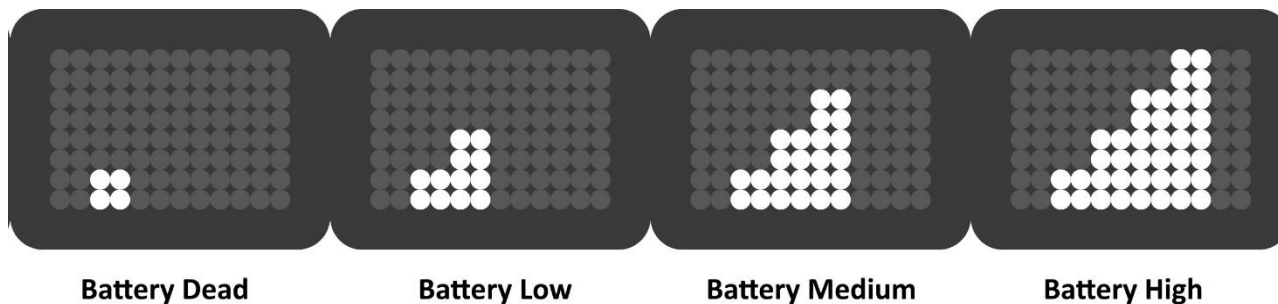

## Optional Features Available Using App.

Your CudaX is fitted with a Bluetooth module that allows it to be connected to an app where you can enable some optional features and change the settings of many more. The App is called “VESC Tool” and is available to purchase in the Apple and Android App stores.



### Connecting

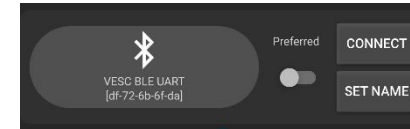

In the App your scooter will appear when it is powered on. Hit Connect and wait a few seconds for everything to load. Once loaded you need to select “APPUI” to open the scooter section. Inside APPUI you will find three pages, Home, Speeds and Settings.

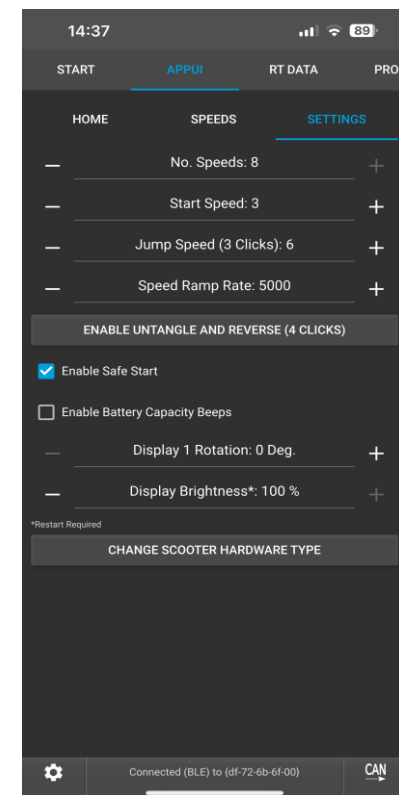
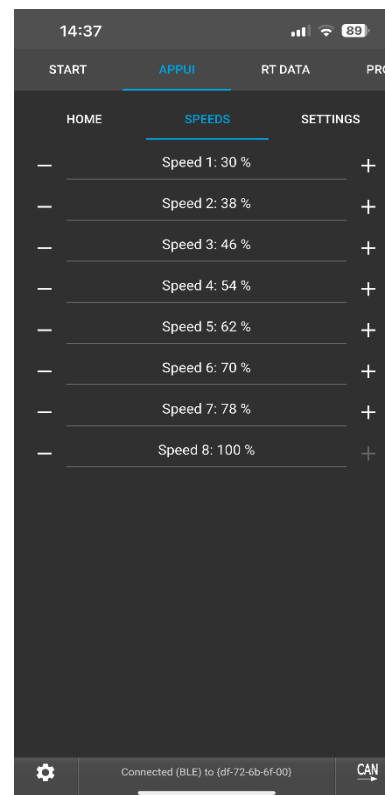
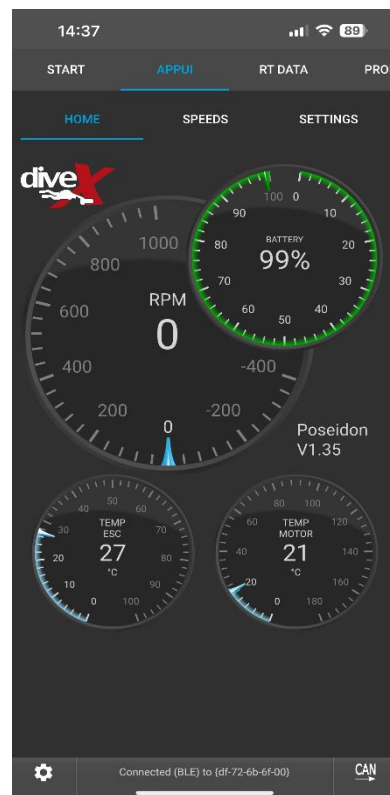

## Changing Settings

All the settings related to the scooter can be found on the APPUI “Speeds” and “Settings” pages. Changing these settings will allow you to customize the operation of your scooter to suit your style of diving. The VESC tool app has many other settings outside the APPUI, however they should NOT be changed as you could cause serious problems with the performance and operation of your scooter.

### Untangle and Reverse: Optional Feature.

Your scooter can be enabled to allow two extra speeds. Untangle and Reverse. Untangle is very slow reverse speed that generates almost zero thrust. It is useful to untangle weeds or fishing line caught in the propellor. Reverse is a higher speed and generates a gentle thrust for moving backwards slowly.

Quadruple clicking the trigger from stopped will enable Untangle, then double clicking and single clicking as normal will switch between the two gears.

**WARNING: When using Untangle and Reverse speeds you must have one hand on the handle and your other on the bottom of the shroud, keeping the tow cord taught. This prevents the scooter backing up into you or sucking the tow cord into the propellor.**

### Battery Beeps: Optional Feature.

If you struggle to see your scooter screen you can now enable Battery Beeps. This feature will give a series of audible beeps matching the number of bars of battery capacity you have remaining. I.e. 3 bars equals 3 beeps. The volume of the beeps can also be set in the app. Beeps will sound a few seconds after motor operation is paused.

## Dive Planning

Your DPV travels much faster than normal swimming speeds. If the user is diving in a buddy pair, they should be more vigilant of their buddy to avoid losing track of them at the increased speeds. These speeds may also increase the risk of collisions with objects and/or other divers, especially in limited visibility situations. Always pay close attention to your buddy, where you are traveling, and your speed to reduce the risk of these incidents occurring.

### Distance & Runtime

Your DPV can travel great distances. Therefore, if it is required that you must return to the same point as you started the dive (the exit), and swimming out or ascending to the surface is not an option, then one should pay close attention to run times of their DPV. Users should empirically calculate their max runtimes from actual dives and plan accordingly using adequate safety margins.

# Scooter Failures

Dive Xtras DPVs are engineered to be extremely reliable. However, divers should always be prepared to deal with failures.

## Flooding

If the DPV floods on the dive, it may become significantly negative and become a risk to the user. The best option is to unclip the DPV via the tow cord bolt snap and release it. This will eliminate the risk and you can safely exit.

## Flood Recovery

Occasionally things go badly. The CudaX is designed to mitigate heavy floods by keeping the battery and motor/electronics compartments separate. Floods may be categorized in 2 ways:

- 1) **Minor flood.** DPV probably still works, and usually isn't detected until you get back to your car, boat, etc.
  - a. Follow the Minor Flood instructions on the next page.
- 2) **Bad flood.** The DPV likely does not work, is heavy and may be smoking, fizzing, or hot if the batteries are damaged.
  - a. If you see any fizzing, smoke, or heat - simply submerge the entire DPV underwater and keep underwater until all heat, smoking, or fizzing has stopped.
  - b. Follow the Major Flood instructions on the next page.

## Minor Flood Instructions:

- 1) **A tiny amount of water (just a few drops), the DPV still works.**
  - a. Wipe them out and try to be more careful opening the DPV and dripping water in from the nose or your dry/wetsuit. Store the scooter somewhere warm and dry to completely dry out.
- 2) **A small amount of water (a few tablespoons), the DPV still works.**
  - a. Remove the batteries and rinse the affected section in fresh water. Invert DPV to drain and dry. Dry everything thoroughly. You have a leak and need to identify what could have caused it. Look for pinched O-rings. Dirt, seaweed, etc.
- 3) **Lots of water, the DPV still works.**
  - a. Remove the batteries and rinse the affected section with fresh water, inside and out. Dry everything thoroughly. You have a leak and need to identify what could have caused it. Look for pinched O-rings. Dirt, seaweed, etc. If the scooter still works after drying it is most likely fine, however, if the flood was in the battery tube the batteries are most likely damaged. If you attempt to reuse the batteries, do so with caution. Charge in a safe, nonflammable space under careful observation.
- 4) **Lots of water, the DPV doesn't work.**
  - a. This is considered a major flood, follow Major Flood Instructions below.

## Major Flood Instructions:

- 1) Don't panic. Determine if flood is affecting the battery compartment or the motor/electronics compartment or both. If you see any fizzing, smoke, or heat from batteries, continue to leave underwater until any heat, smoking or fizzing has stopped.
- 2) Inspect battery compartment: Remove the batteries. If the battery compartment was flooded, rinse the battery compartment inside and out with fresh water and dry thoroughly. Batteries will be damaged, recycle appropriately. Next, remove battery tube and inspect tail section for signs of flooding, follow section 3 if tail section is flooded as well. Contact Dive Xtras for help with repairing your scooter.
- 3) Flooded electronics compartment: Remove batteries and battery tube and set aside. Rinse the tail section, inside and out, in fresh water. Dry everything thoroughly. Contact Dive Xtras for help with repairing your scooter.

## DPV No Longer Runs

If your DPV were to fail and stop running during the dive, you have several options:

- 1) **Swim the DPV**
  - a. If the DPV is not flooded you can simply stow the DPV by clipping it onto your person (in a low drag area if possible, such as a chest D-ring) and then swimming it back.
- 2) **Getting a tow from a buddy**
  - a. If the DPV is not flooded, your buddy can tow you and your failed scooter. The DPV is capable of propelling two people, but for shorter distances and speeds.
- 3) **Release the DPV**
  - a. If the above techniques are unsuitable or increase risk to the user, the best option is to unclip the DPV via the tow cord bolt snap and release it.

## DPV Won't Stop Running

A runaway DPV can be hazardous, as it is a powerful vehicle. If improperly managed, a continuously running DPV might initiate an uncontrolled ascent or decent. It is important to reduce the possibility of a runaway scooter by properly maintaining your DPV and following the various procedures outlined in the operating instructions. If your DPV were to fail during the dive, you have several options:

- 1) **Don't Panic**
  - a. You can typically maneuver the scooter in a circle quite safely while you assess the situation.
- 2) **Lever off the Trigger**
  - a. In the event of a runaway DPV, the trigger may be stuck in the 'On' position. Use your thumb to apply an opposing force on the trigger to lever it into the 'Off' position.
- 3) **Shutoff the DPV**
  - a. The CudaX has a built-in, external power button. Press and hold for at least 3 seconds to power down your scooter.
- 4) **Grabbing the Propeller**
  - a. The DPV is equipped with a Safe Start system that allows you to simply grab the propeller without suffering injury. This will stop the propeller, allowing you to gain control of the scooter.



### 5) Reduce Thrust

- a. By pulling the propeller assembly into the diver's body restricting inlet flow you can reduce the overall thrust to a low level, allowing you to gain control of the DPV.

### 6) Release the DPV

- a. If the techniques are unsuitable or increase risk to the user, the best option is to unclip the DPV via the tow cord bolt snap and release it.

## Post-Dive Procedures

After diving with your DPV, rinse the scooter clean, then run the DPV for a few seconds while pressing the trigger a few times to release any additional water buildup. After that, wipe or use compressed air to spray the scooter dry and remove the batteries, being careful not to allow drips or seepage into the scooter body and battery ports. It's important to do this as soon as possible after diving, and never store your batteries in your scooter. The small power draw of the scooter will eventually drain the batteries and potentially damage them. Store your scooter in a warm, dry location.



## Travel & Storage

The easiest way to pack your DPV for travel is by separating the cylinder body from the tail. After removing the nose cone and vacuum bulkhead, remove the port plug in the bottom of the battery tube and pull firmly on the cylinder to detach it. One tip is to pull the body at an angle to break the connection more easily. After separating the cylinder from the tail, carefully disconnect the three wire connections before doing anything else.

Now that you've gotten your DPV disassembled, it can be packed for travel! Make sure to protect the tail unit and propeller area from damage, and the body can be stored with the nose cone either on or off. We recommend storing your CudaX in a checked bag, as carry-on size and weight restrictions can vary airline to airline.

Your power tool batteries are also safe for travel! While the TSA does not allow loose lithium batteries in checked baggage, they can be safely stored in your carry-on bags by following these protocols. First, make sure your battery ports are protected from contact with other conductive materials, as this can cause a short and create a fire hazard. This can be done by covering each of the battery terminals with tape, sealing your batteries in a plastic bag, or simply leaving the batteries in their original packaging. Secondly, if you plan on traveling with larger capacity batteries like the FlexVolt, make sure to attach the batteries' included travel clip to keep the battery cells separated during travel.

Finally, even after following all these guidelines, the final decision will always come down to the TSA agents and the airline you'll be traveling with. We recommend checking your airline's battery and carry-on policies before you travel and taking every precaution when packing your scooter. Safe travels!



# Maintenance

## Battery Removal

Remove batteries from the DPV prior to any maintenance activity.

## Shroud Removal

It is not necessary to remove the propeller shroud for any routine maintenance. The shroud is only to be removed by Dive Xtras maintenance personnel during a DPV overhaul.

## O-Rings

The most important step in your DPV's maintenance is cleaning and maintaining your O-rings. Start by disassembling your DPV into its main components: the nose cone, vacuum bulkhead, battery tube, and the tail unit. Then remove both O-ring pairs around each section. Clean each O-ring with a clean cloth or paper towel, and wipe around each O-ring groove. Then apply a light coating of silicone gel to the two innermost O-rings. This helps to preserve their sealing ability and lengthen their lifespan. If you notice any cracking or splitting on your O-rings, you'll need to replace them before diving again.

## Propeller

For propeller maintenance, first inspect your DPV's blades for obvious damage. It's common for the leading edges to show signs of wear over time, so look for any damage beyond just nicks and scratches. Next, check the rotation of the prop, making sure it rotates smoothly and does not rub against the prop shroud at all. *(This is usually only a concern if the propeller or shroud has been dropped or damaged, but it's still recommended to check periodically.)* Lastly, although our swept-design propellers are highly effective at shedding foreign objects, there is still a small possibility that your prop may have become entangled. Clear out any kelp or fishing line from around the propeller. If you need to remove the prop, simply remove the large screw in the center of the prop base and reattach once cleaning is complete.

## Trigger

Finally, you'll want to test your trigger. Check for ease of movement. If your trigger is hard to press or doesn't spring up easily, check the spaces around the trigger for debris or blockage. The CudaX trigger has a screw that can be used to lock-out the trigger when not in use, verify functionality. You can usually clear out any foreign material with some compressed air or water into the grooves. If this does not work, contact Dive Xtras for technical support.

After you've completed all these steps, simply reassemble your DPV and store it in a warm, dry location. Remember to remove your batteries from your scooter before storing it.

## Spare Parts

Dive Xtras recommends all users carry the included spares kit. Spare parts are available on the Dive Xtras website including O-Rings, Fuses, Propeller Blades, Noses, and more. Additional spare parts not listed on our website may be procured by contacting customer service at support@dive-xtras.com. Replaced parts may be returned to Dive Xtras for disposal at the cost of the customer or an appropriate local disposal option may be used. Any components replaced during a factory repair will be handled appropriately by the company.

## Troubleshooting

If your DPV's LED displays a battery error, chances are you've encountered a battery mismatch. This is most likely caused by one battery not being as fully charged as the other. Your DPV will display either a number "B1 Lo" or "B2 Lo" to indicate which battery is performing improperly. "1" is for the top battery (closest to the nose), and "2" is for the bottom battery (closest to the tail). Make sure both batteries are fully charged, then try operating your DPV again. If the problem persists, it may be an issue with your battery outputting irregularly, and you may need to replace the battery itself.



## Compliance

### WEEE Compliance (Waste Electrical and Electronic Equipment)

On July 4, 2012, the European Parliament and the Council of the European Union authorized Directive 2012/19/EU or WEEE (Waste Electrical and Electronic Equipment). The aim of the directive is to halt the growing volume of electrical and electronic equipment (EEE) waste disposed of in landfill sites. Dive Xtras Inc. has evaluated its product lines against the criteria set forth in the WEEE directive. As required by the legislation, any Dive Xtras product covered by the directive and sold in the EU after March 1, 2020 is marked with the Wheeled Bin symbol, inserted in the owner's manual or on the packaging. Dive Xtras Inc. uses the symbol based on EN 50419:2006 CENEL-EC standard.

### Disposal of Electrical and Electronic Waste

At the end of the product's life, customers should return their electrical and electronic waste in Dive Xtras Inc. products back to the appropriate company. The appropriate company where it can be recycled and treated appropriately will be marked on the label. Alternatively, a local disposal option may be used if appropriate. Any EEE replaced during a factory repair will be handled appropriately by the company.



# Warranty & Returns

## Standard Warranty

Dive Xtras provides a limited warranty to the original purchaser against all defects in original workmanship and material under normal use and service as outlined in the owner's manual for one year from the date of purchase, with the following exceptions:

1. Any flood or damage, for any reason, that is caused from flooding an O-ring-sealed or watertight area will not be covered under warranty. All O-ring-sealed products undergo extensive factory pressure testing before being shipped and delivered and are therefore guaranteed to be sealed and functioning when shipped from factory.
2. All batteries and chargers are warranted by Rabbit Tool Inc., Deep Sea Supply, AllCell Technologies, or the original battery/charger manufacturer. Dive Xtras is not responsible for any issues arising from the use or misuse of batteries and/or chargers.
3. Dive Xtras will not be liable for any loss, damages, or expenses including incidental or consequential damages directly or indirectly arising from the sale or use of this product.
4. All paint finishing, powder coating, or material stitching that is chipped, damaged, or unthreaded through customer use is not covered under warranty.
5. Dive Xtras does not warranty any product for aesthetic finishes. Issues with surface finish that do not affect function of the product are not covered under warranty.
6. Custom modifications to VESC components will void the warranty for those affected parts.
7. A 6-month warranty on all electronics.

## What Does This Warranty Not Cover?

This limited warranty does not cover any damage due to: (a) transportation; (b) storage; (c) improper use; (d) failure to follow the product instructions or to perform any preventive maintenance; (e) modifications; (f) unauthorized repair; (g) normal wear and tear; or (h) external causes such as accidents, abuse, or other actions or events beyond our reasonable control.

Should your DPV prove to be defective within the terms of this warranty, it will be repaired or replaced (at Dive Xtras' discretion) free of charge with the exclusion of shipping and handling charges. Dive Xtras will not be responsible for any shipping charges to or from Dive Xtras, Inc.

## Return & Replacement Policy

MERCHANDISE SHOULD NOT BE RETURNED WITHOUT AUTHORIZATION.

A Return Material Authorization (RMA) number from our Customer Service department must be obtained before returning goods. Items returned without an RMA number will be subject to inventory charges and fully inspected.

All returns will undergo evaluation. Dive Xtras reserves the right to determine if work falls under warranty. If we determine your return is not covered under warranty, we will contact you regarding any repair charges. All shipping charges, along with non-warranty repair work, are paid for by the equipment's owner.

Returned merchandise will be repaired or replaced at Dive Xtras' discretion.

Unauthorized returns or refused shipments of sellable merchandise will be subject to a 15% restocking fee.

Orders of customized product (custom logo merchandise) are generally not returnable. If an RMA is issued for a customized product, the order is subject to a 40-60% restocking fee, depending on the product.

All items must be freight prepaid.



**Dive Xtras, Inc.**

info@dive-xtras.com

+1 (425) 296-6570

11520 Airport RD

Everett, WA 98204